

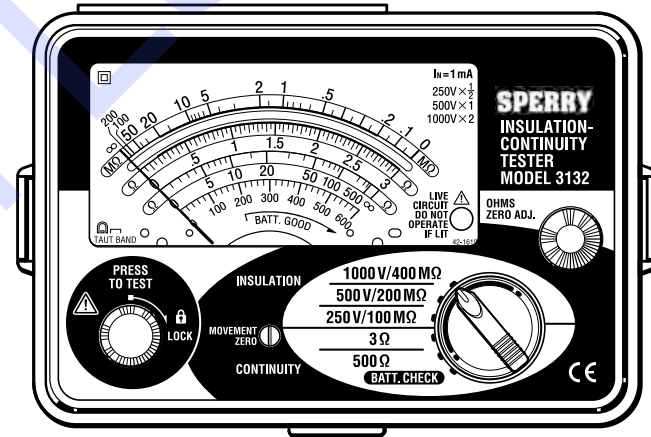

www.byramlabs.com
Branchburg, NJ 08876
Phone: 800-766-1212
Fax: 908-252-0822

OPERATING INSTRUCTION



MODEL 3132
ANALOG INSULATION-CONTINUITY TESTER

CONTENTS

1. Safety Precautions	1
2. Features	4
3. Specifications	5
4. Instrument Layout	8
5. Preparation for Testing	9
5-1 Mechanical Zero Adjustment	9
5-2 Battery Voltage Check	9
5-3 Test Probe Connection	9
5-4 Test Probe check	9
6. Operation	10
6-1 AC Voltage Warning Function	10
6-2 Insulation Resistance Measurement	11
6-3 Continuity Testing (Resistance Tests)	13
7. Battery & Fuse Replacement	15
7-1 Battery Replacement	15
7-2 Fuse Replacement	15
8. Notes on Accessories	16
8-1 Case Lid	16
8-2 How to Fit Strap Belt & Test Probe Pouch	16
9. Cleaning of the Instrument	17
10. Service	17

1. SAFTY PRECAUTIONS

- The instrument is designed and tested in accordance with the following standards and supplied in the best condition.

IEC 61010-1	Measurement CAT.III 300V Pollution Degree 2
IEC 61010-2-31	Safety requirements for hand-held probe assemblies
IEC 61557-1/2/4	Measuring equipment for low voltage distribution systems
IEC 61326-1	EMC
IEC 60529 (IP54)	Dust & drip proof

This instruction manual contains warnings and safety rules which must be observed by the user to ensure safety operation of the instrument and to retain it in safe condition. Therefore, read through these instructions before using the instrument.

⚠ WARNING

- Read through and understand instructions contained in this manual before using the instrument.
- Save and keep the manual handy to enable quick reference whenever necessary.
- The instrument must only be used by a competent trained person and operated in strict accordance with the instructions. A.W.SPEERY will not accept any liability for any damage or injury caused by misuse or non-compliance with the instructions or safety procedures.
- It is essential to understand the safety rules contained in the manual. They must be observed when using the instrument. Be sure to observe the above rules strictly. Not following the instructions may cause injury or instrument damage.

- The symbol ⚠ on the instrument means that the user must refer to the relevant section of this manual for safe operation of the instrument. There are three kinds of the symbol ⚠. Read the instructions following each symbol carefully.

- ⚠ DANGER is reserved for conditions and actions that are likely to cause serious or fatal injury.
- ⚠ WARNING is reserved for conditions and actions that can cause serious or fatal injury.
- ⚠ CAUTION is reserved for conditions and actions that can cause minor injury or instrument damage.

⚠ DANGER

- Do not use this instrument on energized (LIVE) circuits.
- Do not make measurement in the presence of flammable gasses. Otherwise, the use of the instrument may cause sparking, which leads to an explosion.
- Always keep your fingers behind the barrier on test probe during measurement.
- Never use the instrument if its surface or your hand is wet.
- Never open the battery compartment cover while making measurement.

⚠ WARNING

- Do not attempt to take any measurements, if any abnormal conditions are noted, such as broken test probe and cracked enclosure of the instrument.
- Never change ranges with test probe connected to the equipment under test.
- Do not install substitute parts or perform any unauthorized modification of the instrument. Return the instrument to A.W.SPERRY or your distributor for service and repair to ensure the safety features are maintained.
- Do not replace batteries when the surface of the instrument is wet.
- Make sure to disconnect the test probe from the instrument before opening the battery compartment cover for battery replacement.

⚠ CAUTION

- Always make sure to set the range switch to the appropriate position before making measurements.
- Do not expose the instrument to the direct sun, dew fall or extreme temperature and humidity.
- When the instrument will not be in use for a long period of time, place it in storage after removing batteries.
- Use a damp cloth soaked in water or neutral detergent for cleaning the instrument. Do not use abrasives or solvents.

2.Features

MODEL-3132 is an analogue tester with five ranges for insulation resistance measurement and continuity testing (resistance tests) of low voltage installations.

- Designed to safety standards:
 - IEC 61557-1 (General requirements for measuring equipment for low voltage distribution systems)
 - IEC 61557-2 (Equipment for insulation resistance measurement for low voltage distribution systems)
 - IEC 61557-4 (Equipment for resistance tests for low voltage distribution systems)
- Dust and drip proof construction to IP54.
- Three insulation test ranges : 250V/100M Ω ,500V/200M Ω ,1000V/400M Ω .
- Two continuity test ranges : 3 Ω ,500 Ω
- AC voltage warning measurement can be made on all ranges without depressing the test button.
- Easy for battery check.
- When the test button is released any charge stored in the circuit under test is automatically discharged.
- Remaining electric charges can be observed on AC voltage warning range.
- LIVE circuit audible and visual indication.
- Fuse protected.
- Color coded scales and range switch position for easy reading.
- Uses only 6 x 1.5V battery type R6P,1.5V AA or equivalent.

3.Specifications

- Measuring Range and Accuracy (at $23\pm 5^\circ\text{C}$, relative humidity 45-75%)

- Insulation Resistance Ranges:(IEC 61557-2)

Normal output Voltage	250V	500V	1000V
Measuring Ranges	0 - 100M Ω	0 - 200M Ω	0 - 400M Ω
Open -Circuit Voltage	Rated test voltage +20%, -0%		
Normal current	1mA DC +20%, -0%		
Short -Circuit Current	About 1.3mA DC		
Accuracy guaranteed range	0.1-10M Ω	0.2-20M Ω	0.4-40M Ω
Accuracy	$\pm 5\%$ rdg at Accuracy guaranteed ranges $\pm 0.7\%$ of scale length at ranges other than above ranges		

- Continuity Test (Resistance Test) Ranges:(IEC 61557-4)

Ranges	3 Ω	500 Ω
Open -Circuit Voltage	About 4.1V DC	
Measuring Current	Greater than 200mA	
Accuracy	$\pm 1.5\%$ of scale length at other measuring ranges	

Operating Error

Insulation Resistance Ranges(IEC 61557-2)

Ranges	Measuring range to keep operating error	Maximum percentage operating error
250V/100M Ω	0.1M Ω - 10M Ω	$\pm 30\%$
500V/200M Ω	0.2M Ω - 20M Ω	
1000V/400M Ω	0.4M Ω - 40M Ω	

Continuity Test (Resistance Test) Ranges(IEC 61557-4)

Ranges	Measuring range to keep operating error	Maximum percentage operating error
3 Ω	0.2Ω - 3Ω	±30%

The influencing variations used for calculating the operating error are denoted as follows:

Temperature : 0°C and 35°C

Supply voltage : 6.4V to 10.4V

Position : Reference position ±90°

※Prior to measurement, apply 0-Adjustment at each position.

○ AC Voltage Warning:

Warning range	0-600V
Accuracy	±5% of scale length
Input impedance	1.2MΩ

- Typical Number of measurements (central tendency for supply voltage up to 6.0V)

Insulation Resistance Ranges:

1MΩ at 1000V Range Approx. 1,400 times min.

0.5MΩ at 500V Range Approx. 3,500 times min.

0.25MΩ at 250V Range Approx. 5,500 times min.

Continuity Test (Resistance Test) Ranges:

1Ω at 3Ω Range Approx. 1,500 times min.

● Applicable Standards

IEC 61010-1 Measurement CAT.III 300V Pollution Degree 2

IEC 61010-2-31 Safety requirements for hand-held probe assemblies

IEC 61557-1/2/4 Measuring equipment for low voltage distribution systems

IEC 61326-1 EMC

IEC 60529 (IP54) Dust & drip proof

● Operating Temperature & Humidity:

0 - 40° C, relative humidity up to 85%

● Storage Temperature & Humidity:

-10 - 50° C, relative humidity up to 75%

● Insulation Resistance :

More than 50MΩ at 1000V DC between electrical circuit and housing case

● Withstand Voltage: 3700V AC for one minute between electrical circuit and housing case

● Overload Protection Insulation resistance ranges:

1000V Range 1200V (DC+AC p-p) for 10 seconds

500V Range 600V (DC+AC p-p) for 10 seconds

250V Range 300V (DC+AC p-p) for 10 seconds

Continuity ranges:

3Ω/500Ω Range 280V (DC+AC p-p) for 10 seconds

AC Voltage Warning:

1200V (DC+AC p-p) for 10 seconds

● Dimensions: 106(L) x 160(W) x 72(D) mm approx.

● Weight: 560g approx. (including batteries)

● Power Source: 6 x 1.5V battery type R6P, 1.5V AA or equivalent

● Accessories Test Probe MODEL7122 x 1 set

Pouch for test Probe x 1

Shoulder strap x 1

R6P batteries x 6

Spare fuse F500mA/600V x 1

Instruction manual x 1

4. Instrument Layout

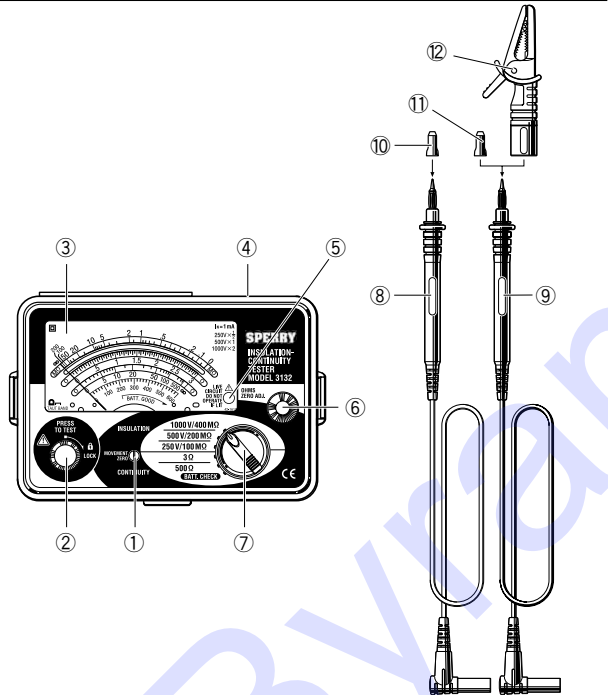

- | | |
|----------------------------------|-------------------------------|
| ① METER MOVEMENT ZERO ADJUST | ② TEST BUTTON |
| ③ SCALE PLATE | ④ INPUT CONNECTOR |
| ⑤ LIVE CIRCUIT LAMP | ⑥ OHMS ZERO ADJUST |
| ⑦ RANGE SELECTOR SWITCH | ⑧ TEST PROBE (RED) LINE PROBE |
| ⑨ TEST PROBE (BLACK) EARTH PROBE | ⑩ TEST PROBE CAP (RED) |
| ⑪ TEST PROBE CAP (BLACK) | ⑫ ALLIGATOR CLIP (BLACK) |

5. Preparation for Testing

5-1 Mechanical Zero Adjustment

Check that the pointer lines up with the middle of the ∞ mark on the scale correctly. If not, adjust it by rotating the meter movement zero adjust with a screwdriver, etc.

5-2 Battery Voltage Check

- ① Set the range selector switch to BATT. CHECK position.
- ② Press the test button.
- ③ Then the pointer deflects. Judge the battery status with BATT.GOOD mark on the scale plate.

If the pointer does not move to BATT.GOOD mark, the batteries are exhausted. Replace them with new batteries according to section 8 for battery & fuse replacement.

5-3 Test Probe Connection

Insert the test probe fully into the terminal of the instrument.

Connect the earth clip of the test probe (black) to EARTH terminal and the line probe (red) to LINE terminal of the connector terminal.

5-4 Test Probe Check

Set the range selector switch to 3Ω position and press and turn the Test button to lock it down.

When the test probe are connected together, the pointer should move from the ∞ position towards the 0 position on the blue ohms scale. If not, the probe or fuse may be faulty.

Release the Test button after completion.

⚠ WARNING

When the test button is pressed with the range selector switch in the megaohm range position, take care not to touch the tip of the test probe where a high voltage is present in order to avoid possible shock hazard.

⚠ CAUTION

Do not keep the test button pressed or locked by turning it clockwise during battery check.

6. Operation

6-1 AC Voltage Warning Function

⚠ DANGER

- Never make measurements with the battery compartment cover removed.

⚠ CAUTION

- Never press the test button if the live circuit warning lamp is lit or the warning buzzer sounds. This may damage the circuit.

Voltage check can be made with the range selector switch at any position.

- ① The presence of AC voltage can be detected. This function operates automatically when the test button is not depressed, i.e., in the up position.
NOTE: This tester has not been designed to indicate the presence of an external DC voltage.
- ② Connect the earth clip of the test probe (black) to the EARTH and the line probe (red) to the LINE side of the circuit under test.
- ③ Take the reading on the AC voltage scale.

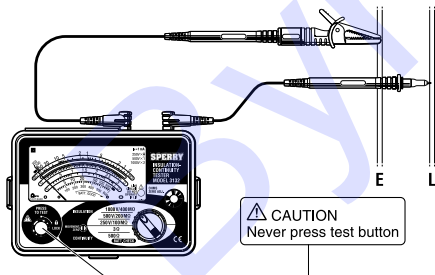

6-2 Insulation Resistance Measurement

⚠ DANGER

- Always test the circuit or equipment to ensure it is surely de-energized before measurement according to the instruction of 6-1.
- To avoid electrical shock, measurements must be performed on de-energized circuits only.
- When the test button is pressed with the range selector switch in the insulation position, take care not to touch the tip of the test probe and the circuit under test where a high voltage is present in order to avoid possible shock hazard.
- Never make measurement with the battery compartment cover removed.

⚠ CAUTION

- Never press the test button if the live circuit warning LAMP is lit or the warning buzzer sounds. This may damage the circuit.
- Conduct the voltage warning check before measurement to ensure that the circuit under test is de-energized.

- ① Check the voltage which can be applied to the circuit under test and set the range selector switch to the desired nominal output voltage range.
- ② Connect the earth clip of the test probe (black) to the earth terminal of the circuit under test.
- ③ Put the tip of the line probe (red) to the circuit under test.

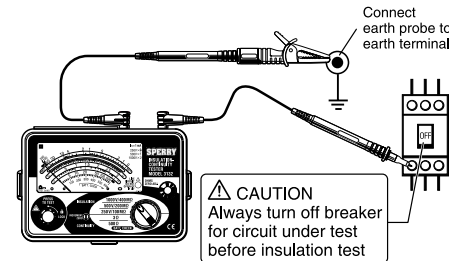

- ④ Check the circuit under test is not energized as follows.
Connect the test probe to the circuit under test and read a voltage value.
If the circuit is live, the meter indicates the voltage, the live circuit lamp is lit, and warning buzzer sounds.
If the meter indicates 0V, the circuit is dead.
- ⑤ Press test button. Read the scale directly for the 500V range, multiply by 0.5 for 250V and by 2 for 1000V.

● Continuous Measurement

A lock down feature is incorporated on the test button. Pressing and turning it clockwise, lock the test button in the continuous operating position.

To release the lock turn the test button counterclockwise.
Never leave the test button locked down when not in use.

⚠ DANGER

Be extremely careful not to get electric shock during insulation resistance measurement as high voltage is present on the tip of the test probe continuously.

- ⑥ With the test probe still connected to the circuit under test after testing, release the test button to discharge capacitance in the circuit.

● Automatic Circuit Capacitance Discharge Function

This function allows the capacitance stored in the circuit under test to be automatically discharged after testing.

Discharge can be monitored by the voltage warning range.

⚠ DANGER

Do not touch the circuit under test immediately after testing. Capacitance stored in the circuit may cause electric shock.
Leave the test probe connected to the circuit and never touch the circuit until the discharge is completed.

● Output voltage characteristics

The insulation resistance tester must be capable of maintaining the

required test voltage when providing a steady state current of 1mA.
The minimum allowable resistance level is 0.25MΩ for the 250V test, 0.5MΩ for the 500V test and 1MΩ for the 1000V test.

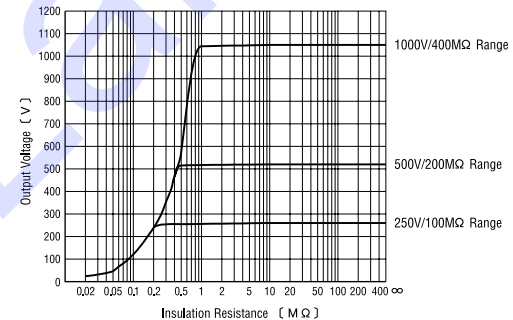

- Principle of Insulation Resistance Measurement
Resistance value can be obtained by applying a certain high voltage to the resistance (insulation resistance) and measuring the flowing current.

$$\text{Resistance Value} = \text{Voltage} / \text{Current}$$

$$RX = V / I$$

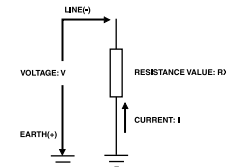

6-3 Continuity Testing (Resistance Tests)

⚠ DANGER

- Always test the circuit or equipment to ensure it is surely de-energized before measurement according to the instruction of 6-1.
- To avoid electrical shock, measurements must be performed on de-energized circuits only.
- Never make measurement with the battery compartment cover removed.

⚠ CAUTION

- Never press the test button if the live circuit warning lamp is lit or the warning buzzer sounds. This may damage the circuit.
- In case that an additional operating circuit is connected in parallel to the circuit under measurement, the measurement error might be caused due to the effects of impedance of the circuit connected in parallel or transient current.

- ① Set the range selector switch to the desired position 3 Ω or 500 Ω.
- ② Short the line probe (red) and the earth clip of the test probe (black) and press the test button. Adjust the ohm zero adjust to zero the pointer on the scale.
- ③ Connect the test probes to the circuit under test.
- ④ Check the circuit under test is not energized as follows.

Connect the test probe to the circuit under test and read a voltage value.

If the circuit is live, the meter indicates the voltage, the live circuit lamp is lit, and warning buzzer sounds. If the meter indicates 0V, the circuit is dead

- ⑤ Press test button. Read the blue ohm scale directly.

● Continuous Measurement

A lock down feature is incorporated on the test button. Pressing and turning it clockwise, lock the test button in the continuous operating position.

To release the lock turn the test button counterclockwise.

Never leave the test button locked down when not in use.

● Principle of Continuity Testing (Resistance Test)

Resistance value can be obtained by applying a certain current to the resistance under test and measuring the voltage generated on the both sides of the resistance under test.

Resistance value = Voltage / Current

$$RX = V / I$$

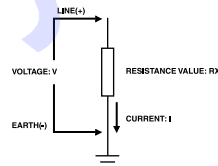

7. Battery & Fuse Replacement

⚠ DANGER

- Never open the battery compartment cover while making measurement. To avoid possible electrical shock, disconnect the test probe before opening the cover for battery and fuse replacement.
- Replacement fuse must have the following rating.
Fast acting type, F 500mA/600V, φ 6.35×32mm

7-1 Battery Replacement

- ① Disconnect the test probe from the instrument.
- ② Open the battery compartment cover by unscrewing the metal captive screw to reveal battery compartment. Always replace all six batteries with new ones at the same time.
Battery type: 6 x 1.5V battery type R6P, 1.5V AA or equivalent
- ③ Screw the battery compartment lid back on before using the instrument.

7-2 Fuse Replacement

- ① Disconnect the test probe from the instrument.
- ② Open the battery compartment cover by unscrewing the metal captive screw to reveal battery compartment and replace the fuse.
Fuse type: 500mA/600V (F) quick acting ceramic fuse 6.35 x 32mm
- ③ Screw the battery compartment lid back on before using the instrument.

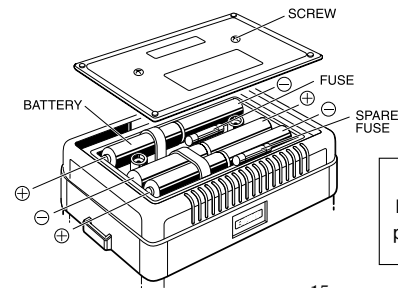

⚠ CAUTION

Install batteries in correct polarity as marked inside.

8. Notes on Accessories

8-1 Case Lid

The case can be fitted under the housing case as illustrated below.

- ① Open the case lid as shown. ② Turn it 180 degrees.

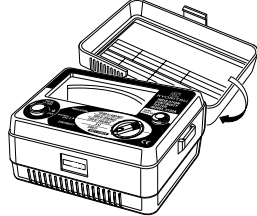
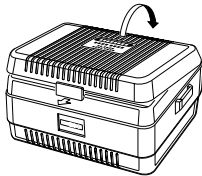

- ③ Put the case lid under the housing case.

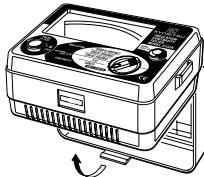

- ④ Hook it on the housing case.

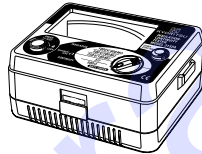

8-2 How to fit Neck Strap & Test Probe Pouch

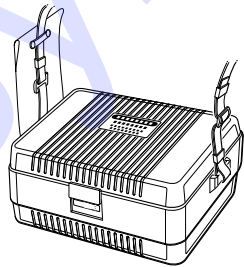

9. Cleaning of the Instrument

◎ Cleaning the meter cover

This tester is managed by our company's quality standard and is delivered in the best condition after passed the inspection. But in the dry time of winter static electricity sometimes builds up on the meter cover due to the characteristic of plastic.

When the pointer deflects by touching the surface of this tester or zero adjustment can not be made, do not try to make measurement.

When static electricity builds up on the meter cover and affects the meter reading, use a cloth dampened with off-the-shelf anti-statics agent or detergent to wipe the meter cover surface.

10. Service

If this tester should fail to operate correctly, return it to your nearest distributors stating the exact nature of the fault.

Before returning the unit, make sure that:

- Operating instructions have been followed
- Leads have been inspected
- Fuse has been checked
- Battery has been checked
- The unit is returned with all accessory leads

Remember, the more information written about the fault, the quicker it will be serviced.