

User Guide

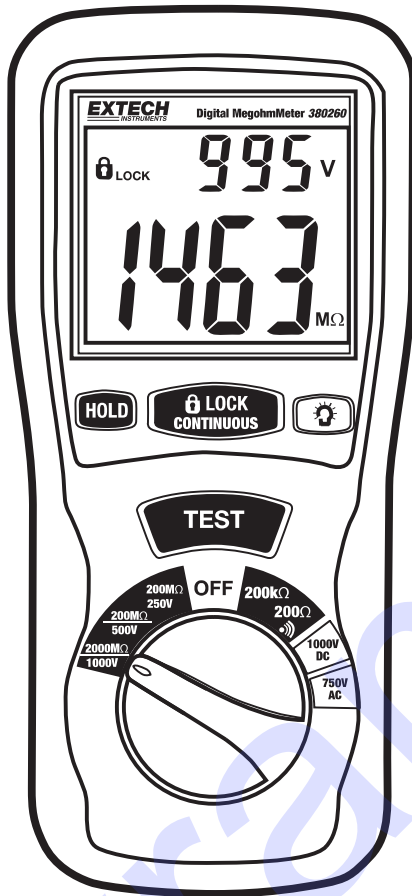

Model 380260
Insulation Tester / Megohmmeter



www.byramlabs.com
Branchburg, NJ 08876
Phone: 800-766-1212
Fax: 908-252-0822

Introduction

Congratulations on your purchase of Extech's Insulation Tester/Megohmmeter. The Model 380260 provides three test ranges plus continuity and AC/DC voltage measurement. A handy test lock feature and a data hold function are also included. This professional meter, with proper care, will provide years of reliable service.

Safety

1. Circuits under test must be de-energized and isolated before connections are made (except for voltage measurements).
2. Circuit connections must not be touched during a test. Use extreme caution when working near bare conductors and bus bars. Accidental contact with conductors could result in electrical shock.
3. Use caution when working near voltages above 60VDC or 30VACrms.
4. After insulation tests, capacitors must be discharged.
5. Test leads (including alligator clips) must be in good working order, clean and without broken or cracked insulation.
6. When servicing, use only specified replacement parts.

International Safety Symbols



Caution, refer to this manual before using this meter



Dangerous Voltages



Meter is protected throughout by double or reinforced insulation

Meter Description

1. LCD Display
2. Hold Button
3. Test Button
4. Rotary Switch
5. Backlight Button
6. Lock Button
7. Input Terminals

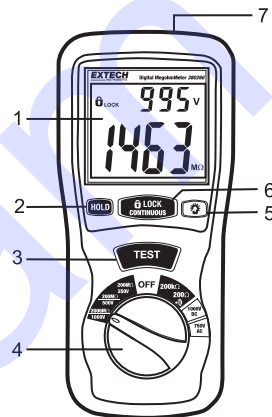

Operation

Warning

Ensure that the circuit under test does not include components that can be damaged by 1000VDC; such devices include power factor correction capacitors, low voltage mineral insulated cables, electronic light dimmers, and ballasts/starters for fluorescent lamps.

Connecting Test Leads

For all measurements, connect the red test lead to the $V\Omega$ input terminal and the black test lead to the COM input terminal.

Test Lead Check

1. Set the rotary switch to the 200Ω  range.
2. Touch the test lead tips together.
3. Resistance should read less than 0.5Ω and the audio tone should sound.
4. With the leads not touching, the display should read infinity indicated by "1".
5. Readings displayed other than the readings described above are indicative of a test lead problem. The test leads must be replaced before using the meter. Failure to do so could result in damage to equipment and electrical shock.

Insulation Resistance Measurements (Megohmmeter Tests)

Warning: Do not perform Insulation Resistance measurements if AC Voltage is present on the device under test.

1. Connect the red test lead to the $V\Omega$ input terminal; black lead to the COM terminal.
2. Set the function switch to the desired $M\Omega$ test voltage position.
3. Connect the tips of the test leads to the equipment under test. If there is a voltage present, a constant beep will sound and the voltage will be displayed.
4. The display will show "1" until the TEST button is pushed. Press and hold the TEST button. The upper right display shows the test voltage applied and the flashing high voltage symbol  will be displayed. The main display shows the resistance.
5. Keep the test leads connected to the equipment under test and release the TEST button. The circuit will discharge through the meter. Keep the test leads connected until the circuit is completely discharged and the upper right display shows 0 volts.

Lock Function

For hands-free operation, use the LOCK feature.

1. With the test leads connected to the equipment under test, simultaneously press the TEST and LOCK keys.
2. The LOCK icon  "Lock" will appear on the display. A beeper will sound every 2 seconds to indicate that the meter is in Lock mode.
3. Press the LOCK key to disable the Lock function and end the test.

Notes on IR (Megohmmeter) testing:

1. The maximum measurement range for the 380260 is 2000M Ω . Frequently, insulation resistance will exceed this value. When this happens, the display will indicate "1", meaning the resistance is very high and the insulation being tested is good.
2. If the device being tested is highly capacitive, the display will indicate an increasing resistance value over time. Always wait until the reading has stabilized before recording the value.

AC/DC Voltage Measurement

1. Set the Rotary switch to the ACV or DCV position.
2. Connect the red test lead to the V Ω terminal and the black test lead to the COM terminal.
3. Connect the test leads to the circuit under test.
4. Read the voltage value on the LCD.

Resistance Measurement

WARNING

Do not run this test unless ACV = 0. Do not use this mode to check diodes.

1. Set the Rotary switch to the 200k Ω position.
2. Connect the red test lead to the V Ω terminal and the black lead to the COM terminal.
3. Connect the tips of the test leads to the circuit under test.
4. Read the resistance value on the display.

Low Resistance (Continuity) Measurement

1. Set the Rotary switch to the 200 Ω  position.
2. Connect the red test lead to the V Ω terminal and the black lead to the COM terminal.
3. Connect the tips of the test leads to the circuit under test.
4. Read the resistance value on the display. When the resistance of a circuit is less than approx. 40 Ω , the audible tone will sound.

Auto Power Off

To conserve battery life, the meter will automatically turn off after approx. 15 minutes of non-use. To turn the meter back on, turn the rotary switch to OFF, then to the desired function.

Hold Function

The hold function freezes the reading in the display. Press the HOLD key momentarily to activate or to exit the hold function

Backlight

Press the  key for to turn on the display backlight function. The backlight will automatically turn off after 15 seconds.

Applications

Measuring Power Tools and Small Appliances

This section applies to any device under test that uses a line cord. For double insulated power tools, the meter's leads should be connected to the device's housing (chuck, blade, etc.) and the lines of the power cord.

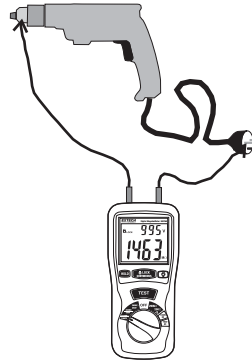

Testing AC Motors

Disconnect the motor from the line by disconnecting the wires from the motor terminals or opening the mains switch.

If the mains switch is opened, and the motor also has a motor-starter, then the starter must be held in the ON position. With the mains switch opened, the measured resistance will include the resistance of the motor wire and all other components between the motor and the main switch. If a weakness is indicated, the motor and other components should be checked individually. If the motor is disconnected at the motor terminals, connect one meter lead to the grounded motor housing and the other lead to one of the motor leads. Refer to diagram at below.

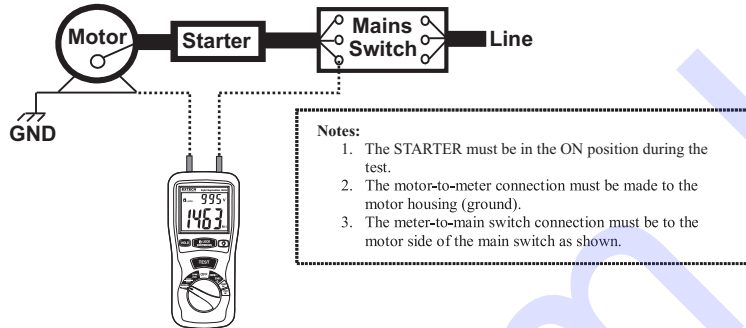

Testing DC Motors

1. Disconnect the motor from the line.
2. To test the brush rigging, field coils and armature, connect one meter lead to the grounded motor housing and the other lead to the brush on the commutator.
3. If the resistance measurement indicates a weakness, raise the brushes off of the commutator and separately test the armature, field coils and brush rigging (one at a time). Leave one lead connected to the grounded motor housing while testing the motor components. This also applies to DC Generators.

Testing Cables

1. Disconnect the cable under test from the line.
2. Disconnect the opposite end of the cable to avoid errors as a result of leakage from other equipment.
3. Check each conductor to ground and/or lead sheath by connecting one meter lead to ground and/or lead sheath and the other meter lead to each of the conductors in turn.
4. Check insulation resistance between conductors by connecting meter leads to conductors in pairs. Refer to diagram at right.

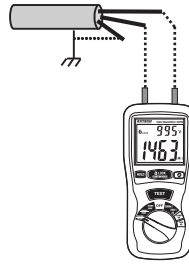

Specifications

Range Specifications

Accuracies are specified as % reading + digits at 23°C ± 5°C < 80% RH

MEGOHMMETER RANGES

Range	Resolution	Accuracy	Terminal Voltage
200MΩ/250V	0.1MΩ	±3% + 5d	250V + 10% ~ -0%
200MΩ/500V	0.1MΩ	±3% + 5d	500V + 10% ~ -0%
0-1000MΩ/1000VDC	1MΩ	±3% + 5d	1000V + 10% ~ -0%
1000-2000MΩ/1000VDC	1MΩ	±5% + 5d	1000V + 10% ~ -0%

Range	Test Current	Short Circuit Current
200MΩ/250V	250kΩ (load)	<1mA
200MΩ/500V	500kΩ (load)	
0-1000MΩ/1000VDC	1MΩ	
1000-2000MΩ/1000VDC		

AC VOLTAGE (40Hz-400Hz)

Range	Resolution	Accuracy	Input Impedance	Overload Protection
750VAC	1V	±1.2% + 10d	10MΩ	750Vrms

DC VOLTAGE

Range	Resolution	Accuracy	Input Impedance	Overload Protection
1000VDC	1V	±0.8% + 3d	10MΩ	1000Vrms

RESISTANCE

Range	Resolution	Accuracy	Max. Open Circuit Voltage	Overload Protection
200Ω	0.1Ω	±1% + 2d	4.5V	250Vrms
200kΩ	0.1kΩ	±1% + 2d	3V	250Vrms

General specifications

Display	LCD with dual display
Sampling rate	2.5 readings per second
Continuity beeper	<40Ω, short circuit current <200mA, open circuit voltage 4.5V
Over range indicator	'1' displayed
Zero adjust	Automatic
Low battery indicator	Low battery symbol displayed when battery voltage is low
Environmental	Installation category II, Pollution Degree 2, Altitude up to 2000 meters, Indoor use only
Power source	Six (6) 1.5 'AA' batteries
Fuse	250mA/600V ceramic 3AG Fast blow
Operating conditions	32 to 104°F (0 to 40°C); 80% RH
Storage conditions	14 to 140°F (-10 to 460°C); <80% RH
Dimensions	7.8 x 3.6 x 1.9" (200 x 92 x 50mm)
Weight	24.6oz (700g)
IEC 1010	CAT III-1000V
Approvals	CE

Maintenance

Battery Replacement

When the low battery symbol  appears on the LCD, the six 1.5V 'AA' batteries must be replaced.

1. Turn the meter off and remove the test leads
2. Unsnap the tilt stand from the rear of the meter
3. Remove the four Phillips head screws holding the battery cover
4. Remove the battery compartment cover
5. Replace the batteries observing polarity
6. Affix the rear cover and secure the screws.
7. Reattach the tilt stand

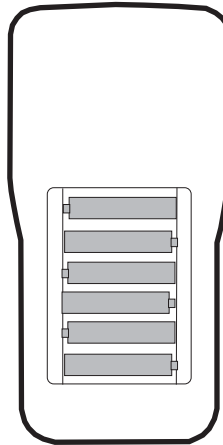

Cleaning

Periodically wipe the case with a dry cloth. Do not use solvents or abrasives to clean this instrument.

Repair and Calibration

Extech offers repair and calibration services for the products we sell. Extech also provides NIST certification for most products. Call the Customer Service Department for information on calibration services available for this product. Extech recommends that annual calibrations be performed to verify meter performance and accuracy.

Warranty

EXTECH INSTRUMENTS CORPORATION warrants this instrument to be free of defects in parts and workmanship for one year from date of shipment (a six month limited warranty applies on sensors and cables). If it should become necessary to return the instrument for service during or beyond the warranty period, contact the Customer Service Department at (781) 890-7440 ext. 210 for authorization or visit our website at www.extech.com (click on 'Contact Extech' and go to 'Service Department' to request an RA number). A Return Authorization (RA) number must be issued before any product is returned to Extech. The sender is responsible for shipping charges, freight, insurance and proper packaging to prevent damage in transit. This warranty does not apply to defects resulting from action of the user such as misuse, improper wiring, operation outside of specification, improper maintenance or repair, or unauthorized modification. Extech specifically disclaims any implied warranties or merchantability or fitness for a specific purpose and will not be liable for any direct, indirect, incidental or consequential damages. Extech's total liability is limited to repair or replacement of the product. The warranty set forth above is inclusive and no other warranty, whether written or oral, is expressed or implied.

Copyright © 2006 Extech Instruments Corporation.

All rights reserved including the right of reproduction in whole or in part in any form.